

M2

Data Sheet

Safety precautions

Never stand in the immediate vicinity of loudspeakers driven at a high level. Professional loudspeaker systems are capable of causing a sound pressure level detrimental to human health. Seemingly non-critical sound levels (from approx. 95 dB SPL) can cause hearing damage if people are exposed to it over a long period.

In order to prevent accidents when deploying loudspeakers on the ground or when flown, please take note of the following:

When setting up the loudspeakers or loudspeaker stands, make sure they are standing on a firm surface. If you place several systems on top of one another, use straps to secure them against movement.

Only use accessories which have been tested and approved by d&b for assembly and mobile deployment. Pay attention to the correct application and maximum loading capacity of the accessories as specified in our "Rigging accessories" manual.

Ensure that all additional hardware, fixings and fasteners used for installation or mobile deployment are of an appropriate size and load safety factor. Pay attention to the manufacturers instructions and to the relevant safety guidelines.

Regularly check the loudspeaker housings and accessories for visible signs of wear and tear, and replace them when necessary.

Regularly check all load bearing bolts in the mounting devices.

Loudspeakers produce a static magnetic field even if they are not connected or are not in use. Therefore make sure when erecting and transporting loudspeakers that they are nowhere near equipment and objects which may be impaired or damaged by an external magnetic field. Generally speaking, a distance of 0.5 m (1.5 ft) from magnetic data carriers (floppy disks, audio and video tapes, bank cards, etc.) is sufficient; a distance of more than 1 m (3 ft) may be necessary with computer and video monitors.

WARNING!

CAUTION!

General Information

Data sheet M2

Version 4.0 E, 02/2001, D2092.E.04

© by d&b audiotechnik AG 1995-2001; all rights reserved.

The information presented in this document is, to the best of our knowledge, correct. We will however not be held responsible for the consequences of any errors or omissions.

Technical specifications, weights and dimensions should always be confirmed with d&b audiotechnik AG prior to inclusion in any additional documentation.

d&b audiotechnik AG

Eugen-Adolff-Strasse 134, D-71522 Backnang

Telephone +49-7191-9669-0, Fax +49-7191-95 00 00

M2

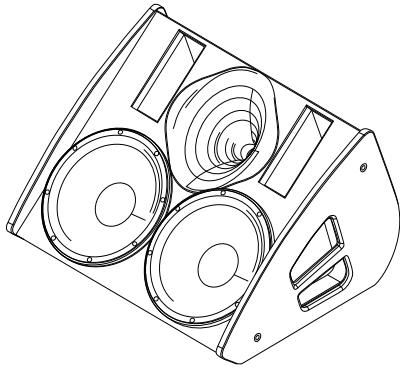

The M2 is a high performance 2-way active monitor system using two 12" LF drivers in an airflow-optimised bass-reflex cabinet. It contains a 1.4" HF driver using a compact but extremely strong neodymium magnet assembly, mounted on a low distortion horn optimized for monitor applications. The design allows the use of a low height cabinet while achieving a constant directivity from an unusual 600 Hz upwards with a nominal dispersion of 45° (h) x 60° (v). Together with the cabinets baffle angle of 40° (to floor), this dispersion offers a realistic artist listening area starting directly above the cabinet and ranging for quite a distance upstage.

The M2 is driven actively using the A1 mainframe with M2 controller module. Two M2 cabinets can be driven from one A1 mainframe.

The M2 cabinet is constructed from marine plywood and has an impact resistant paint finish. The cabinet is protected by a rigid metal grill backed with an acoustically transparent foam. Two fittings which accept Ball-lock shackle pins are located on both sides of the cabinet allowing quick and flexible rigging. Fitted on the rear panel are two CA-COM connectors allowing linking of paired cabinets.

The M2, as a 2-way high performance monitor producing a remarkable peak sound pressure level of 143 dB – the most powerful d&b system so far, provides a constant directivity which raises the feedback level significantly and gives very direct voice reproduction. The M2 bestows its full dynamics across the entire frequency range without compromising the solo voices or instruments, which always stay clearly and audibly in front of the mix.

For applications which require deep bass, the LF response can be extended by using additional active subwoofer system C7-SUB.



M2 stage monitor

M2-CO Controls and indicators

CUT switch and indicator

Set to CUT, a high pass filter with a 110 Hz cut-off frequency is inserted in the controller signal path. The yellow CUT LED illuminates. M2 is now configured for use with d&b C7-SUB active subwoofer.

LFC level control

The detented **L**ow **F**requency **C**oupling control adjusts the systems lo- and lo-mid response to different operating environments of the M2 system.

The **FLOOR** position is the standard setting for a single M2, used as floor monitor.

Turning the control to the **PAIR** position, the lo- and lower mid frequency range is more and more reduced (Corner frequency about 600Hz). The maximum left position fully compensates the different coupling behaviour of the low and high frequencies when two cabinets are used in a paired monitor application.

Turning towards **FREE** increases the systems low end for operation without floor coupling (e.g. flown).

Indicators

These indicators give a three stage indication of the M2 Controller signal levels.

- **ISP (Input Signal Present, green)** illuminates when the signal presented to the controller input exceeds a -36 dBu threshold value. The ISP circuit is unaffected by the setting of the controller mute switch and level control.
- **GR (Gain Reduction, yellow)** illuminates when the controller limiter reduces gain by more than 3 dB.
- **OV (Overload red)** illuminates when the controller limiter reduces gain by more than 12 dB or overload occurs in the signal path (input signal too high) or when the amplifier gain is reduced because the output current is too high (e.g. due to a short circuit).

The limiter indicators show the stage of the HF and LF channels independently.

Level Control

The detented level control adjusts the controller input sensitivity. It has a 20 dB range (-14 dB ... +6 dB) calibrated in 1 dB steps. The controls are normally set to 0 dB.

Connector

The M2 controller incorporates one CA-COM 8 pin output for driving one or two (linked) M2 loudspeakers. Different from the F-series controller, the M2 controller uses female connectors for protection against contact.

The M2 cabinet incorporates two CA-COM (male/female) connectors for easy linking of two cabinets.

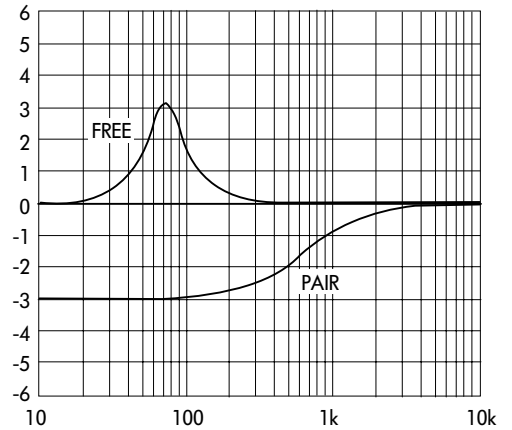

Frequency response LFC-Funktion (min. and max.)

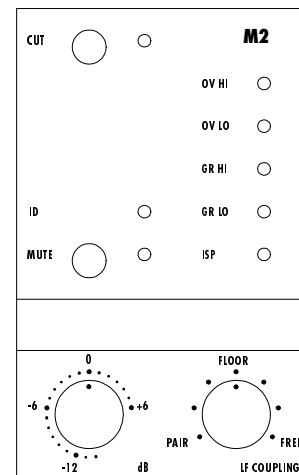

Controls and indicators
M2 Controller Modul

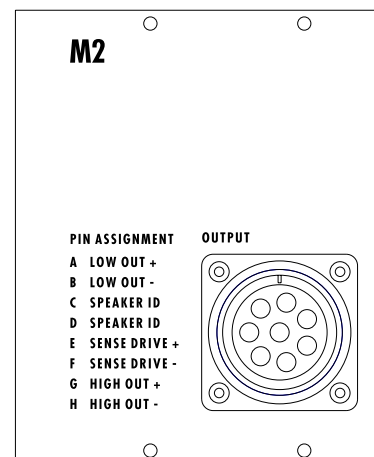

M2 Controller,
CA-COM connector plate

Dispersion characteristics

The diagram below shows dispersion angle v. frequency plotted using lines of equal sound pressure (isobars) at -6 dB and -12 dB. The nominal 45° horizontal dispersion angle is maintained from 800 Hz to 10 kHz.

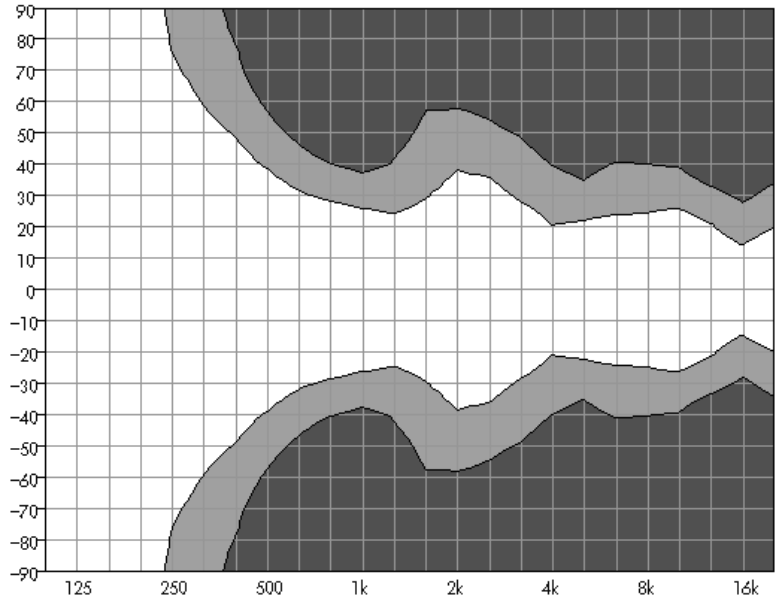

M2 isobar diagram horizontal

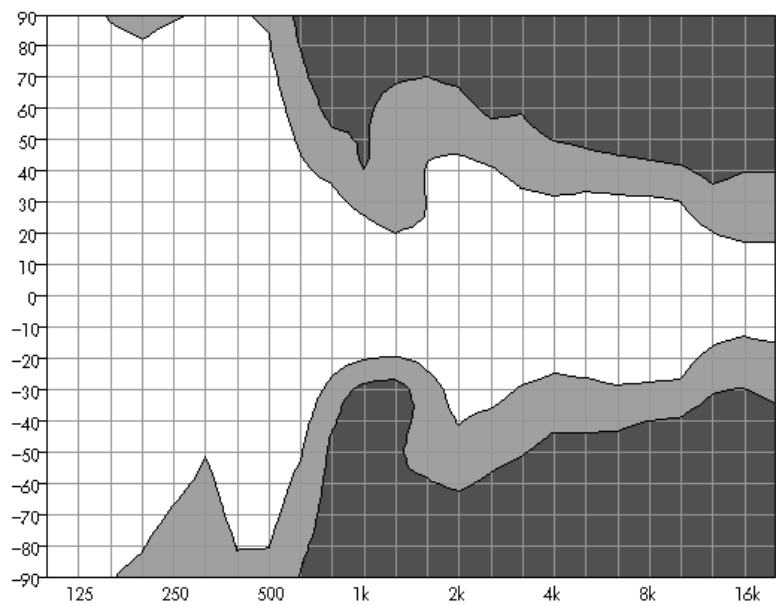

M2 isobar diagram vertical

Frequency response

The graph below shows the frequency response of the M2 system in floor monitor position, measured in a height of 1.7m (listening pos. in monitor operation) on axis:

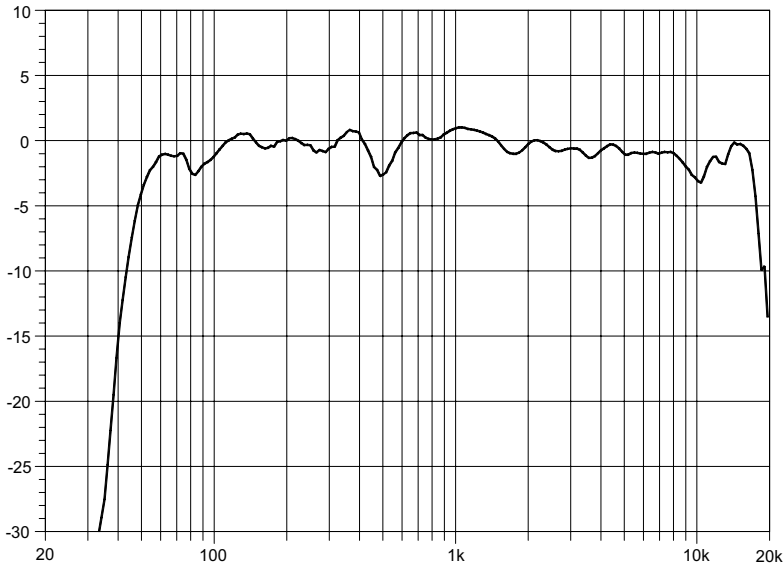

M2 frequency response, monitor operation

Technical specifications

M2 system data

Frequency response (-5 dB, free field)	56 Hz - 17 kHz
Frequency response (-5 dB, floor coupling).....	50 Hz - 17 kHz
Max. sound pressure level (1 m, free field)	143 dB
(SPLmax peak, pink noise test signal with crest factor of 4)	
Input level (SPLmax).....	+18 dBu
Input level (100 dB-SPL / 1 m)	-26 dBu
Polarity to controller INPUT (XLR pin 2: + / 3: -).....	LF: - / HF: -

M2 loudspeaker

Nominal impedance LOW/HIGH	4 / 8 ohms
Power handling capacity LOW (RMS / peak 10 ms).....	500 / 2000 W
Power handling capacity HIGH (RMS / peak 10 ms)	50 / 200 W
Nominal dispersion angle (h x v)	45° x 60°
Connections	2 x 8-pin CA-COM
Weight	38 kg (83 lb)

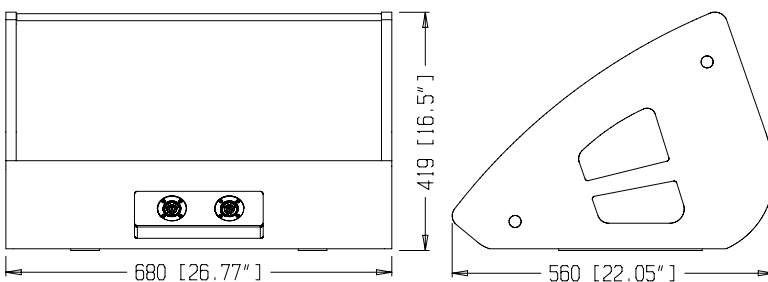

M2 cabinet dimensions in mm [inch]